

## Low-Cost, Mono/Stereo, 1 W Differential Audio Power Amplifiers

### ■ General Description

The LN4890 is an audio power amplifier primarily designed for demanding applications in mobile phones and other portable communication device applications. It is capable of delivering 1 watt of continuous average power to an 8Ω BTL load with less than 1% distortion (THD+N) from a 5V DC power supply. Boomer audio power amplifiers were designed specifically to provide high quality output power with a minimal amount of external components. The LN4890 does not require output coupling capacitors or bootstrap capacitors, and therefore is ideally suited for mobile phone and other low voltage applications where minimal power consumption is a primary requirement.

The LN4890 features a low-power consumption shutdown mode, which is achieved by driving the shutdown pin with logic low. Additionally, the LN4890 features an internal thermal shutdown protection mechanism. The LN4890 contains advanced pop & click circuitry which eliminates noises which would otherwise occur during turn-on and turn-off transitions. The LN4890 is unity-gain stable and can be configured by external gain-setting resistors.

### ■ Key Specifications

- PSRR @ $f_{IN} = 217\text{Hz}$ ,  $V_{DD} = 5\text{V}$  62dB(typ.)
- Power Output @ $V_{DD} = 5.0\text{V}$  & 1% THD 1W(typ.)
- Power Output @ $V_{DD} = 3.3\text{V}$  & 1% THD 400mW(typ.)
- Shutdown Current 0.1μA(typ.)

### ■ Operating Ratings

Temperature Range

$T_{MIN} \leq T_A \leq T_{MAX}$ -----  $-40^{\circ}\text{C} \leq T_A \leq 85^{\circ}\text{C}$

Supply Voltage -----  $2.2\text{V} \leq V_{DD} \leq 5.0\text{V}$

### ■ Features

- Available in space-saving packages
- Ultra low current shutdown mode
- BTL output can drive capacitive loads
- Improved pop & click circuitry eliminates noises during turn-on and turn-off transitions
- 2.2 - 5.0V operation
- No output coupling capacitors, snubber networks or bootstrap capacitors required
- Thermal shutdown protection
- Unity-gain stable
- External gain configuration capability

### ■ Applications

- Mobile Phones
- PDAs
- Portable electronic devices

### ■ Package

- MSOP-8
- SOP-8

### ■ Ordering Information

Ordering Number	Package
LN4890MM	MSOP-8
LN4890M	SOP-8

## Pin Configuration

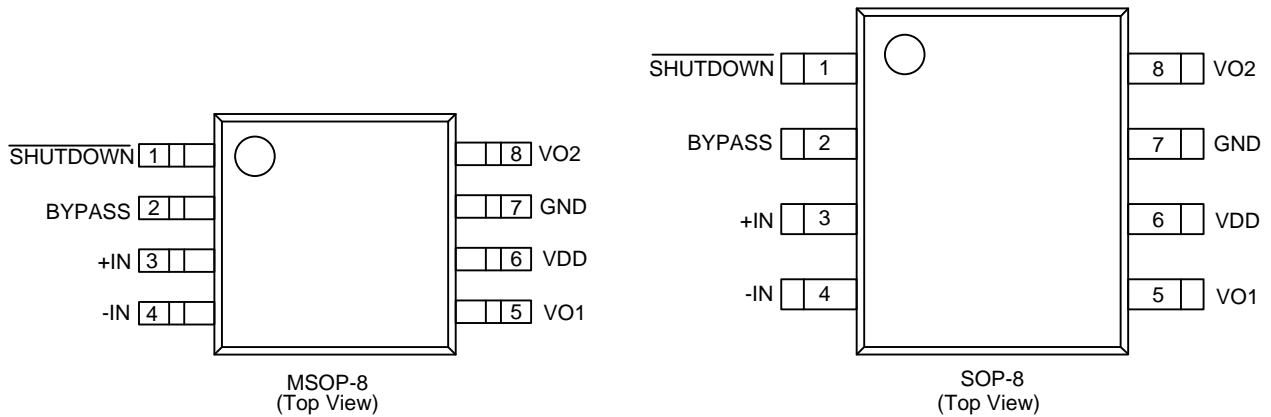

## Pin Function Description

Pin Number	Pin Name	Function Description
1	SHUTDOWN	Chip Enable (Low Effective)
2	BYPASS	Bypass Capacitance Input Pin
3	+IN	Positive Input Terminal (Differential +)
4	-IN	Negative Input Terminal (Differential -)
5	VO1	Negative Output Terminal (Differential -)
6	VDD	Power Supply
7	GND	Ground Pin
8	VO2	Positive Output Terminal (Differential +)

## Marking Rule

- MSOP-8、SOP-8

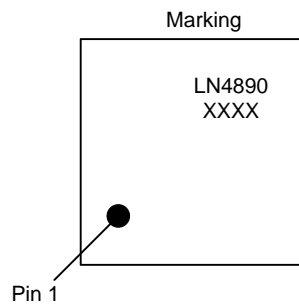

XXXX: Date Code

■ Typical Application Circuit

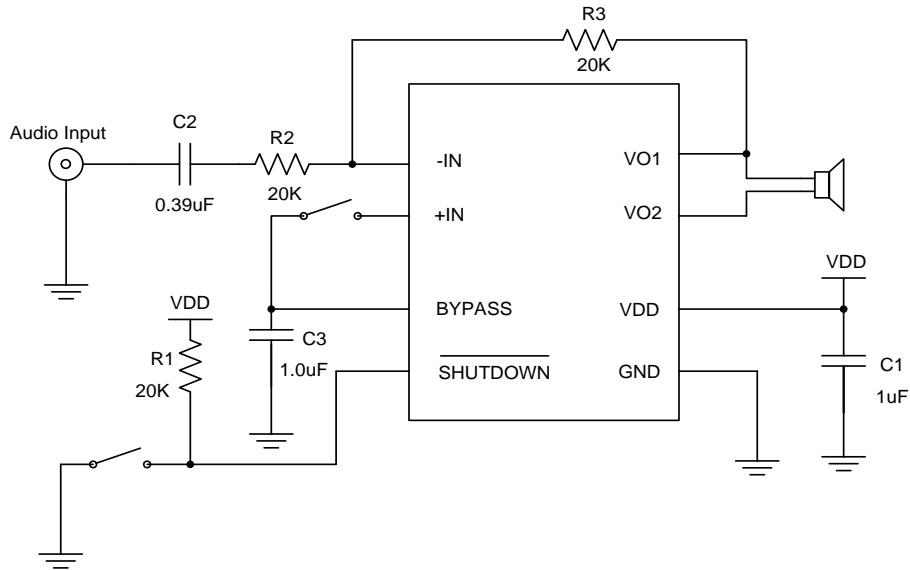

■ Absolute Maximum Ratings

Parameter	Symbol	Value	Unit
Supply Voltage	$V_{DD}$	-0.3—5.0	V
Input Voltage	$V_{IN}$	-0.3— $V_{DD}+0.3$	V
Operation Temperature	$T_{opr}$	-40—85	°C
Storage Temperature	$T_{stg}$	-65—150	°C
ESD Susceptibility	-	2000	V

■ Function Block Diagram

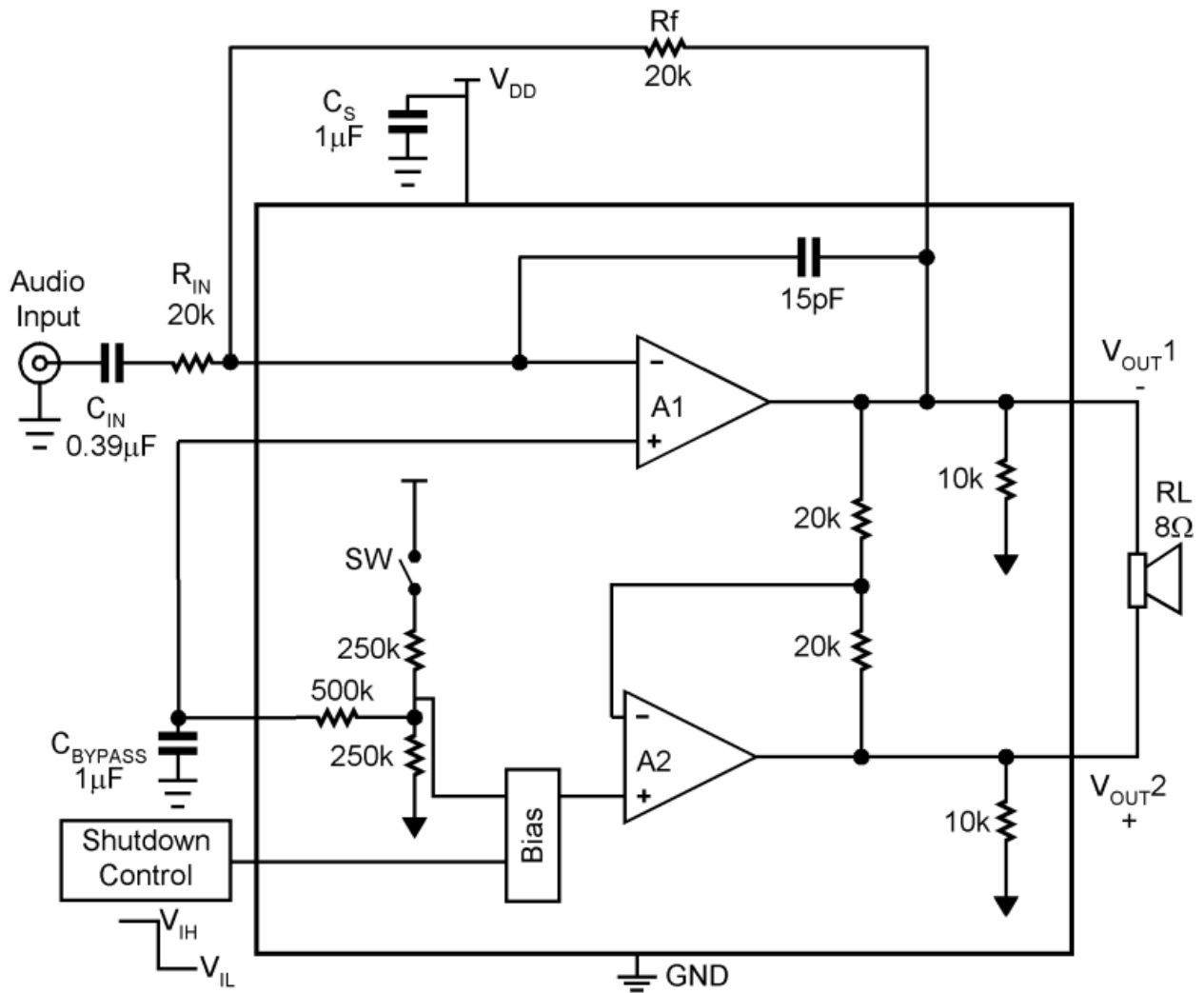

**Electrical Characteristics**

(VDD = 5V Unless otherwise specified. Limits apply for TA = 25°C.)

Parameter	Symbol	Condition	Min	Typ	Max	Unit
I <sub>DD</sub>	Quiescent Power Supply Current	V <sub>IN</sub> = 0V, I <sub>o</sub> = 0A, No Load	—	4	8	mA
		V <sub>IN</sub> = 0V, I <sub>o</sub> = 0A, 8Ω Load	—	5	10	mA
I <sub>SD</sub>	Shutdown Current	V <sub>SHUTDOWN</sub> = 0V	—	0.1	2	μA
V <sub>SDIH</sub>	Shutdown Voltage Input High		1.2	—	—	V
V <sub>SDIL</sub>	Shutdown Voltage Input Low		—	—	0.4	V
V <sub>OS</sub>	Output Offset Voltage		—	7	50	mV
R <sub>OUT-GND</sub>	Resistor Output to GND		7.0	8.5	9.7	kΩ
P <sub>O</sub>	Output Power ( 8Ω )	THD = 2% (max); f = 1 kHz 8Ω Load	0.8	1.0	—	W
T <sub>WU</sub>	Wake-up time		—	170	220	ms
T <sub>SD</sub>	Thermal Shutdown Temperature		150	170	190	°C
THD+N	Total Harmonic Distortion+Noise	P <sub>o</sub> = 0.4 Wrms; f = 1kHz	—	0.1	—	%
PSRR	Power Supply Rejection Ratio	V <sub>ripple</sub> = 200mV <sub>sine p-p</sub> f=217Hz	55	62	—	dB
		V <sub>ripple</sub> = 200mV <sub>sine p-p</sub> f=1kHz		66		
T <sub>SdT</sub>	Shut Down Time	8Ω Load	—	1.0	—	ms

(VDD = 3V Unless otherwise specified. Limits apply for TA = 25°C.)

Parameter	Symbol	Condition	Min	Typ	Max	Unit
I <sub>DD</sub>	Quiescent Power Supply Current	V <sub>IN</sub> = 0V, I <sub>o</sub> = 0A, No Load	—	3.5	7	mA
		V <sub>IN</sub> = 0V, I <sub>o</sub> = 0A, 8Ω Load	—	4.5	9	mA
I <sub>SD</sub>	Shutdown Current	V <sub>SHUTDOWN</sub> = 0V	—	0.1	2	μA
V <sub>SDIH</sub>	Shutdown Voltage Input High		1.2	—	—	V
V <sub>SDIL</sub>	Shutdown Voltage Input Low		—	—	0.4	V
V <sub>OS</sub>	Output Offset Voltage		—	7	50	mV
R <sub>OUT-GND</sub>	Resistor Output to GND		7.0	8.5	9.7	kΩ
P <sub>O</sub>	Output Power ( 8Ω )	THD = 2% (max); f = 1 kHz 8Ω Load	0.28	0.31	—	W
T <sub>WU</sub>	Wake-up time		—	170	220	ms
T <sub>SD</sub>	Thermal Shutdown Temperature		150	170	190	°C
THD+N	Total Harmonic Distortion+Noise	P <sub>o</sub> = 0.4 Wrms; f = 1kHz	—	0.1	—	%
PSRR	Power Supply Rejection Ratio	V <sub>ripple</sub> = 200mV <sub>sine p-p</sub> f=217Hz	45	56	—	dB
		V <sub>ripple</sub> = 200mV <sub>sine p-p</sub> f=1kHz		62		

(VDD = 2.6V Unless otherwise specified. Limits apply for TA = 25°C.)

Parameter	Symbol	Condition	Min	Typ	Max	Unit	
I <sub>DD</sub>	Quiescent Power Supply Current	V <sub>IN</sub> = 0V, I <sub>o</sub> = 0A, No Load	—	2.6	5.5	mA	
I <sub>SD</sub>		V <sub>SHUTDOWN</sub> = 0V	—	0.1	2	μA	
P <sub>O</sub>	Output Power ( 8Ω )	THD = 1% (max); f = 1 kHz		8Ω Load	0.2	—	W
				4Ω Load	0.22		
THD+N	Total Harmonic Distortion+Noise	P <sub>o</sub> = 0.1 Wrms; f = 1kHz	—	0.08	—	%	
PSRR	Power Supply Rejection Ratio	V <sub>ripple</sub> = 200mV <sub>sine p-p</sub> f=217Hz	—	44	—	dB	
		V <sub>ripple</sub> = 200mV <sub>sine p-p</sub> f=1kHz		44			

Typical Performance Characteristics

THD+N vs Frequency  
at  $V_{DD} = 5V$ ,  $8\Omega R_L$ , and  $PWR = 250mW$ ,  $A_V = 2$

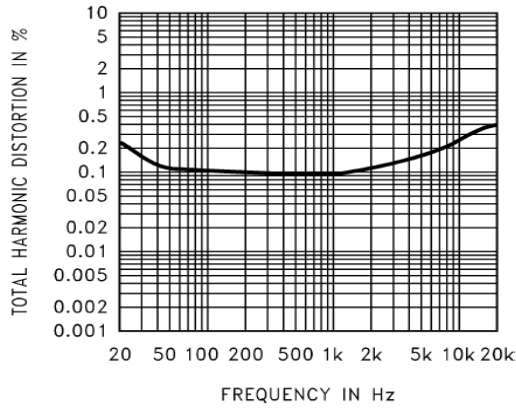

THD+N vs Frequency  
at  $V_{DD} = 3.3V$ ,  $8\Omega R_L$ , and  $PWR = 150mW$ ,  $A_V = 2$

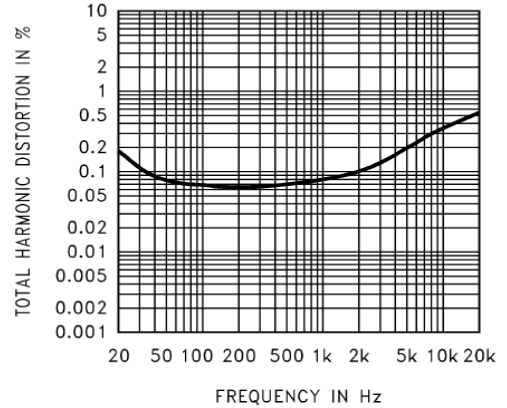

THD+N vs Frequency  
at  $V_{DD} = 3V$ ,  $R_L = 8\Omega$ ,  $PWR = 250mW$ ,  $A_V = 2$

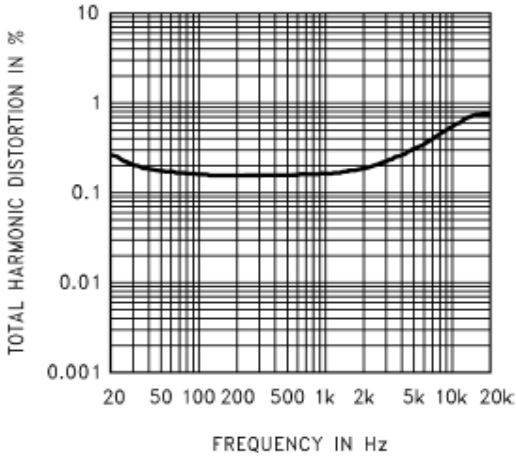

THD+N vs Frequency  
@  $V_{DD} = 2.6V$ ,  $R_L = 8\Omega$ ,  $PWR = 100mW$ ,  $A_V = 2$

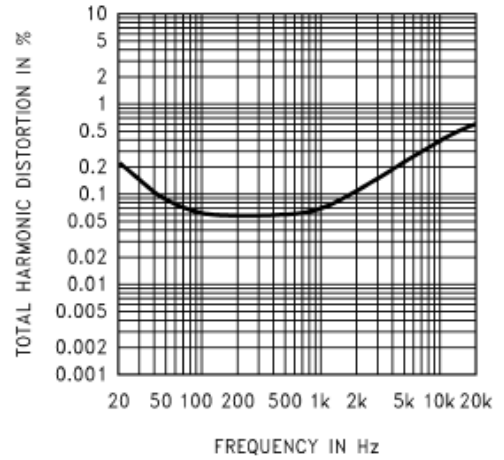

THD+N vs Frequency  
@  $V_{DD} = 2.6V$ ,  $R_L = 4\Omega$ ,  $PWR = 100mW$ ,  $A_V = 2$

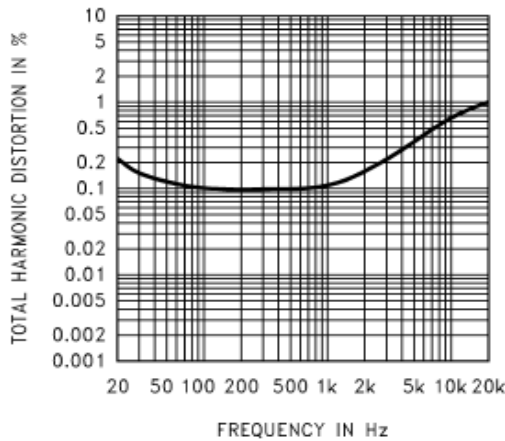

THD+N vs Power Out  
@  $V_{DD} = 5V$ ,  $R_L = 8\Omega$ ,  $1kHz$ ,  $A_V = 2$

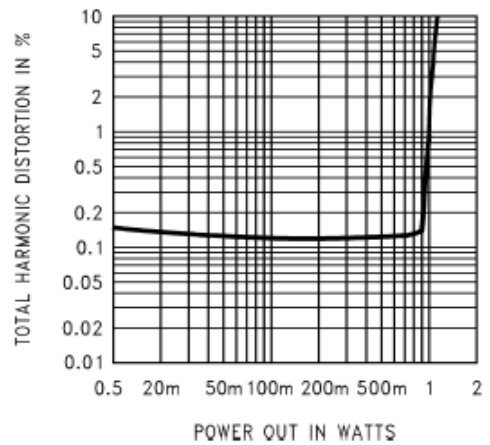

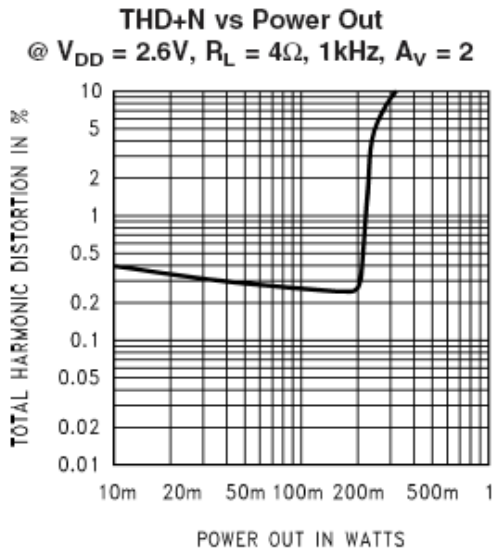
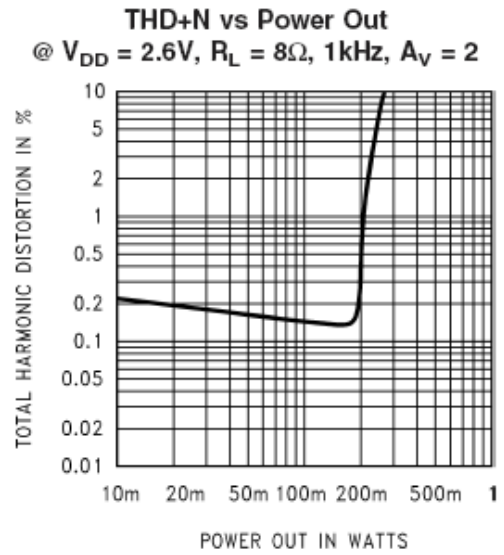
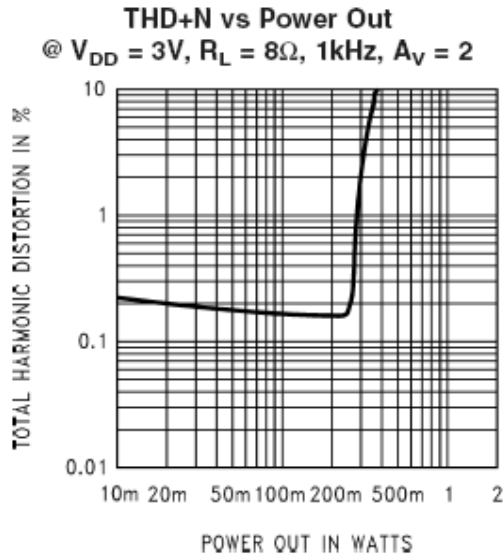

**Power Supply Rejection Ratio (PSRR) @  $A_V = 2$**   
 $V_{DD} = 5V, V_{ripple} = 200mvp-p$   
 $R_L = 8\Omega, R_{IN} = 10\Omega$

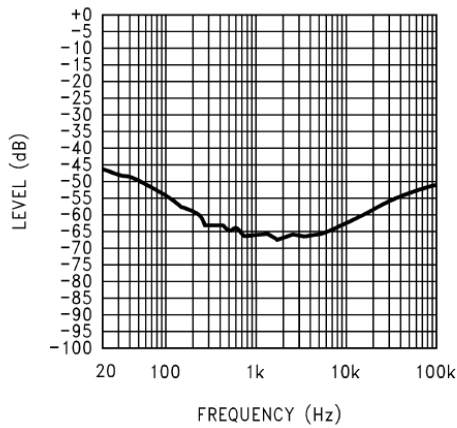

**Power Supply Rejection Ratio (PSRR) @  $A_V = 2$**   
 $V_{DD} = 5V, V_{ripple} = 200mvp-p$   
 $R_L = 8\Omega, R_{IN} = Float$

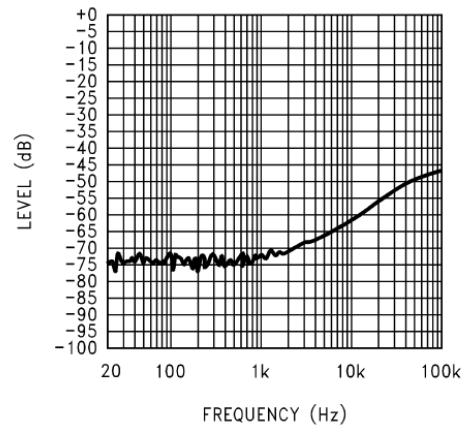



Power Supply Rejection Ratio (PSRR) @  $A_V = 4$

$V_{DD} = 5V$ ,  $V_{ripple} = 200mvp-p$   
 $R_L = 8\Omega$ ,  $R_{IN} = 10\Omega$

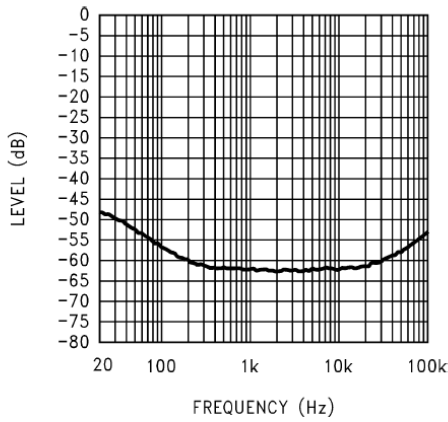

Power Supply Rejection Ratio (PSRR) @  $A_V = 4$

$V_{DD} = 5V$ ,  $V_{ripple} = 200mvp-p$   
 $R_L = 8\Omega$ ,  $R_{IN} = Float$

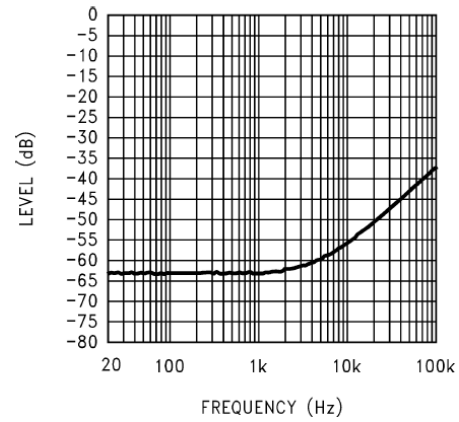

Power Supply Rejection Ratio (PSRR) @  $A_V = 2$

$V_{DD} = 3V$ ,  $V_{ripple} = 200mvp-p$ ,  
 $R_L = 8\Omega$ ,  $R_{IN} = 10\Omega$

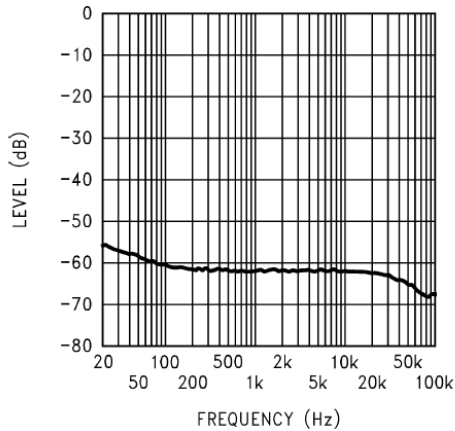

Power Supply Rejection Ratio (PSRR) @  $A_V = 2$

$V_{DD} = 3V$ ,  $V_{ripple} = 200mvp-p$ ,  
 $R_L = 8\Omega$ ,  $R_{IN} = Float$

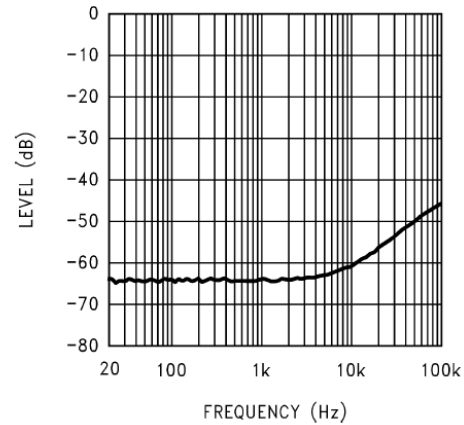

Power Supply Rejection Ratio (PSRR) @  $A_V = 4$

$V_{DD} = 3V$ ,  $V_{ripple} = 200mvp-p$ ,  
 $R_L = 8\Omega$ ,  $R_{IN} = 10\Omega$

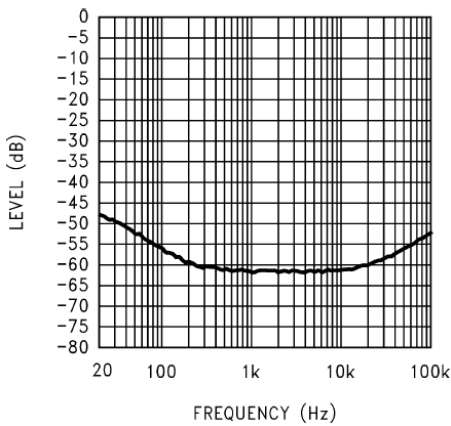

Power Supply Rejection Ratio (PSRR) @  $A_V = 4$

$V_{DD} = 3V$ ,  $V_{ripple} = 200mvp-p$ ,  
 $R_L = 8\Omega$ ,  $R_{IN} = Float$

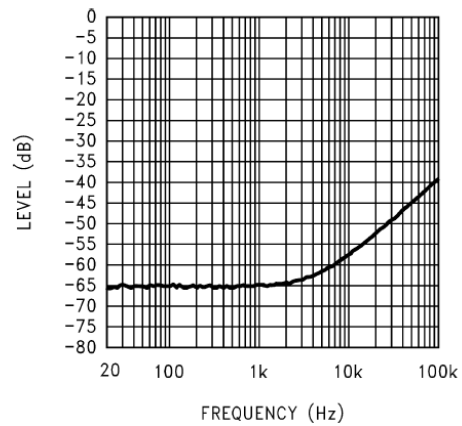

Power Supply Rejection Ratio (PSRR) @  $A_V = 2$

$V_{DD} = 3.3V$ ,  $V_{ripple} = 200mvp-p$ ,  
 $R_L = 8\Omega$ ,  $R_{IN} = 10\Omega$

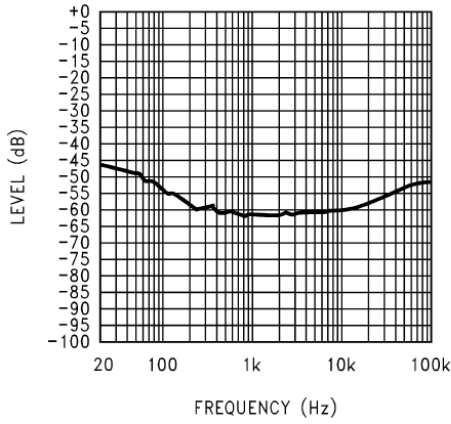

Power Supply Rejection Ratio (PSRR) @  $A_V = 2$

$V_{DD} = 2.6V$ ,  $V_{ripple} = 200mvp-p$ ,  
 $R_L = 8\Omega$ ,  $R_{IN} = 10\Omega$

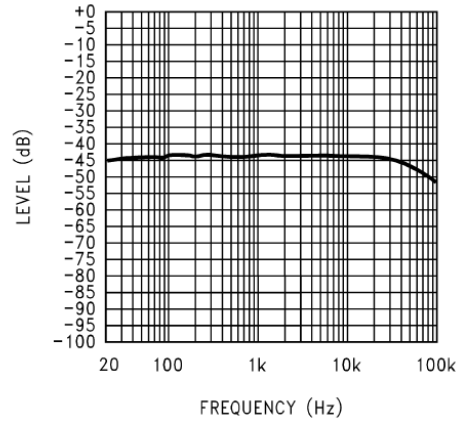

PSRR vs DC Output Voltage

$V_{DD} = 5V$ ,  $A_V = 10$

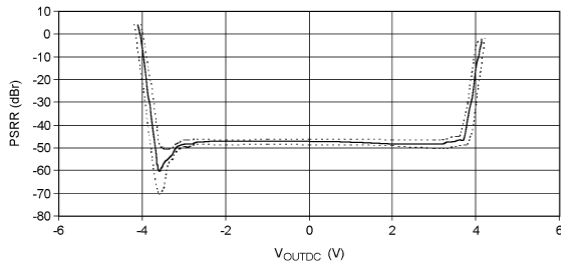

PSRR vs DC Output Voltage

$V_{DD} = 3V$ ,  $A_V = 2$

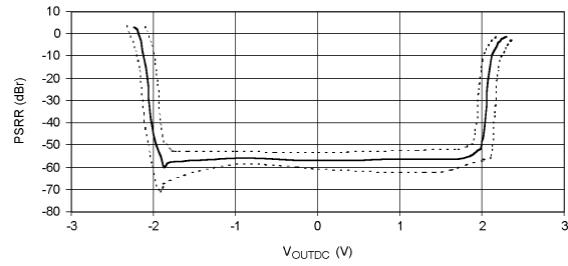

PSRR vs DC Output Voltage

$V_{DD} = 3V$ ,  $A_V = 4$

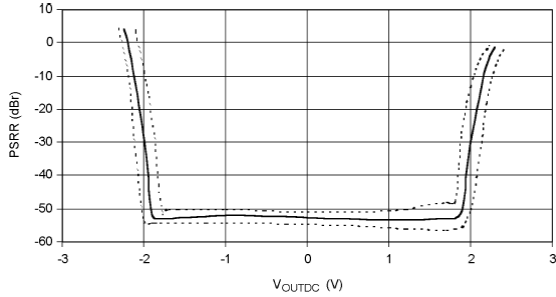

PSRR vs DC Output Voltage

$V_{DD} = 3V$ ,  $A_V = 10$

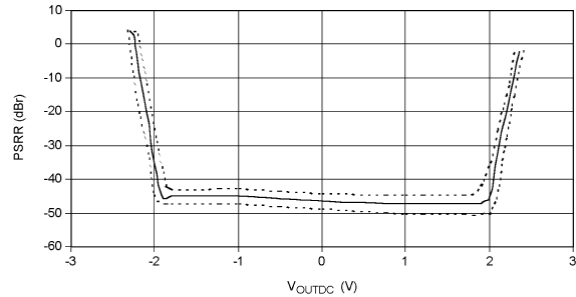

PSRR Distribution  $V_{DD} = 5V$

217Hz, 200mvp-p,  
-30, +25, and +80°C

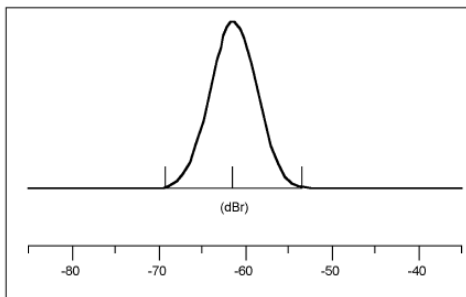

PSRR Distribution  $V_{DD} = 3V$

217Hz, 200mvp-p,  
-30, +25, and +80°C

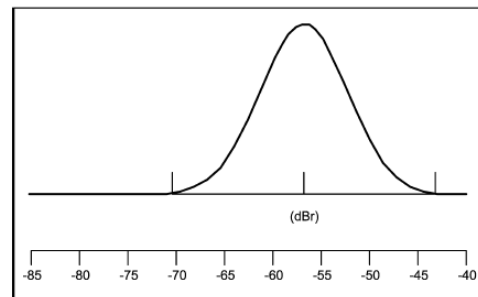

Power Supply Rejection Ratio vs Bypass Capacitor Size

$V_{DD} = 5V$ , Input Grounded =  $10\Omega$ , Output Load =  $8\Omega$

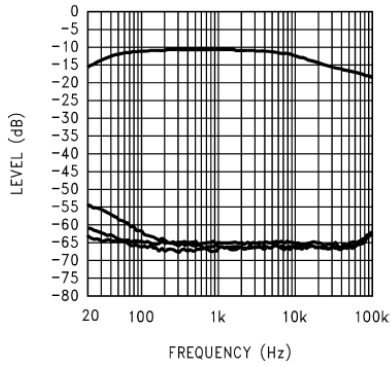

Top Trace = No Cap, Next Trace Down =  $1\mu f$   
Next Trace Down =  $2\mu f$ , Bottom Trace =  $4.7\mu f$

Power Supply Rejection Ratio vs Bypass Capacitor Size

$V_{DD} = 3V$ , Input Grounded =  $10\Omega$ , Output Load =  $8\Omega$

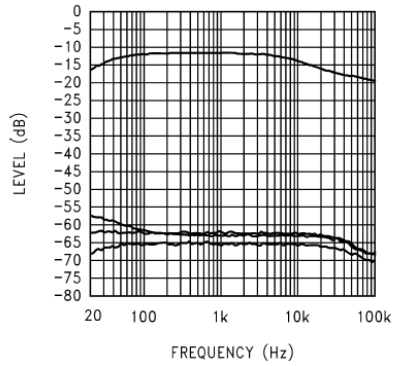

Top Trace = No Cap, Next Trace Down =  $1\mu f$   
Next Trace Down =  $2\mu f$ , Bottom Trace =  $4.7\mu f$

Output Offset Voltage

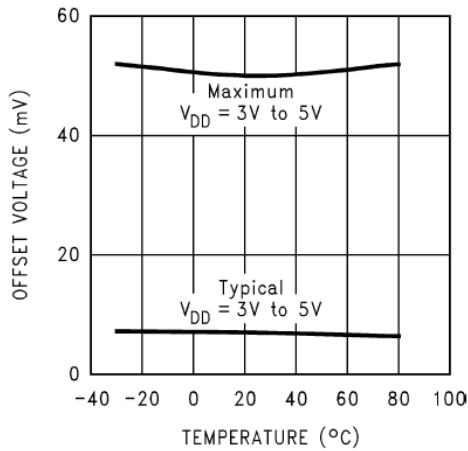

Supply Current vs Shutdown Voltage

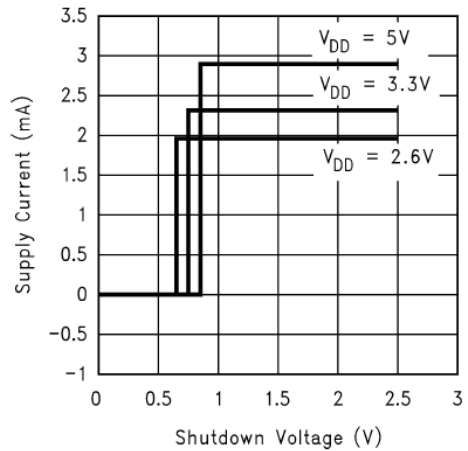

Shutdown Hysteresis Voltage  
 $V_{DD} = 5V$

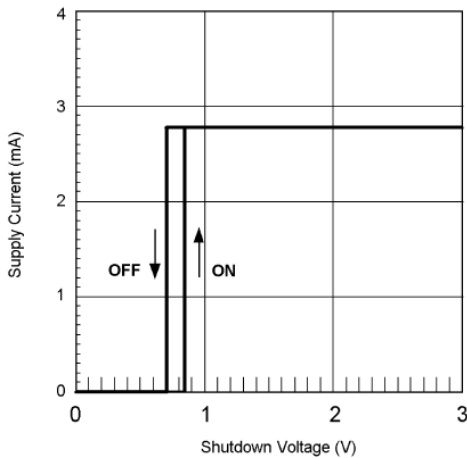

Shutdown Hysteresis Voltage  
 $V_{DD} = 3V$

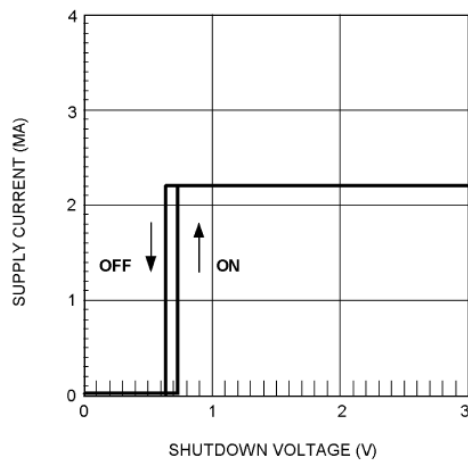

Open Loop Frequency Response  
 $V_{DD} = 5V$ , No Load

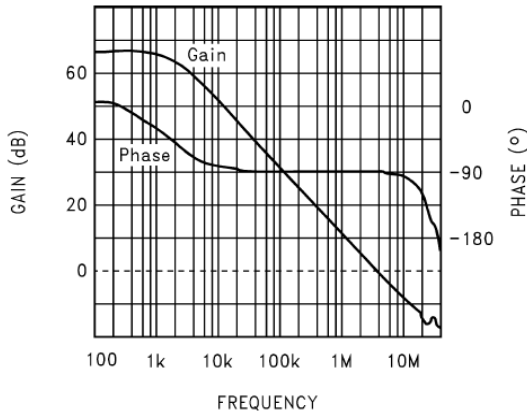

Open Loop Frequency Response  
 $V_{DD} = 3V$ , No Load

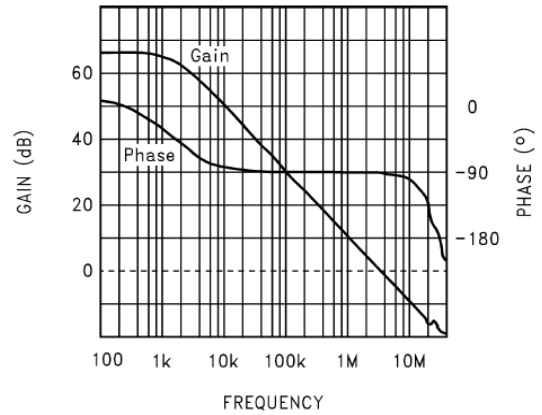

Gain / Phase Response,  $A_V = 2$   
 $V_{DD} = 5V$ ,  $8\Omega$  Load,  $C_{LOAD} = 500pF$

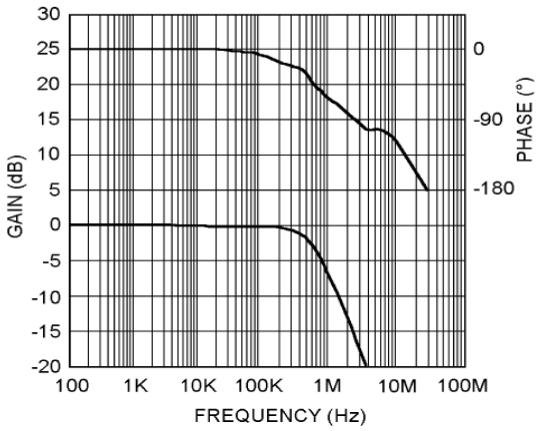

Gain / Phase Response,  $A_V = 4$   
 $V_{DD} = 5V$ ,  $8\Omega$  Load,  $C_{LOAD} = 500pF$

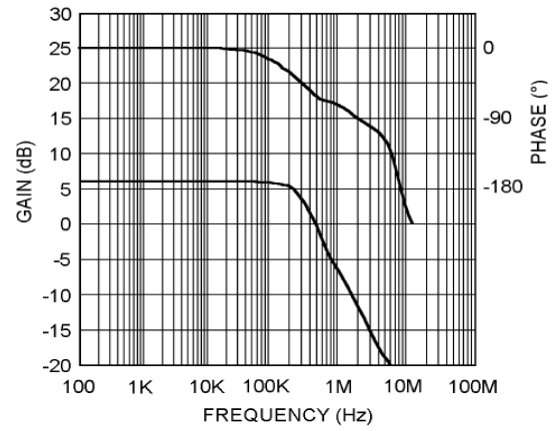

Phase Margin vs  $C_{LOAD}$ ,  $A_V = 2$   
 $V_{DD} = 5V$ ,  $8\Omega$  Load  
Capacitance to gnd on each output

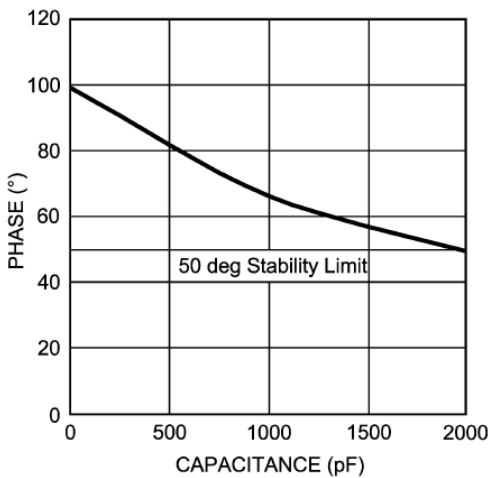

Phase Margin vs  $C_{LOAD}$ ,  $A_V = 4$   
 $V_{DD} = 5V$ ,  $8\Omega$  Load  
Capacitance to gnd on each output

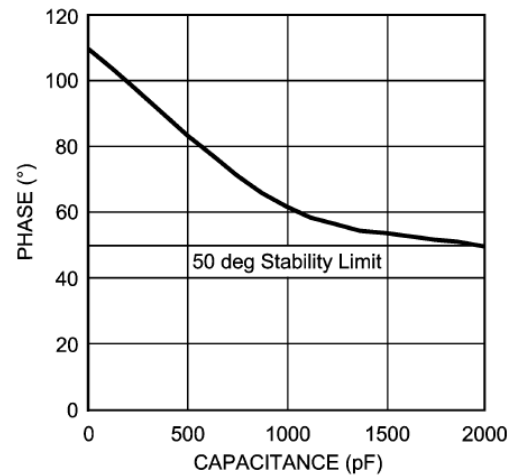

■ Package Information

- MSOP-8

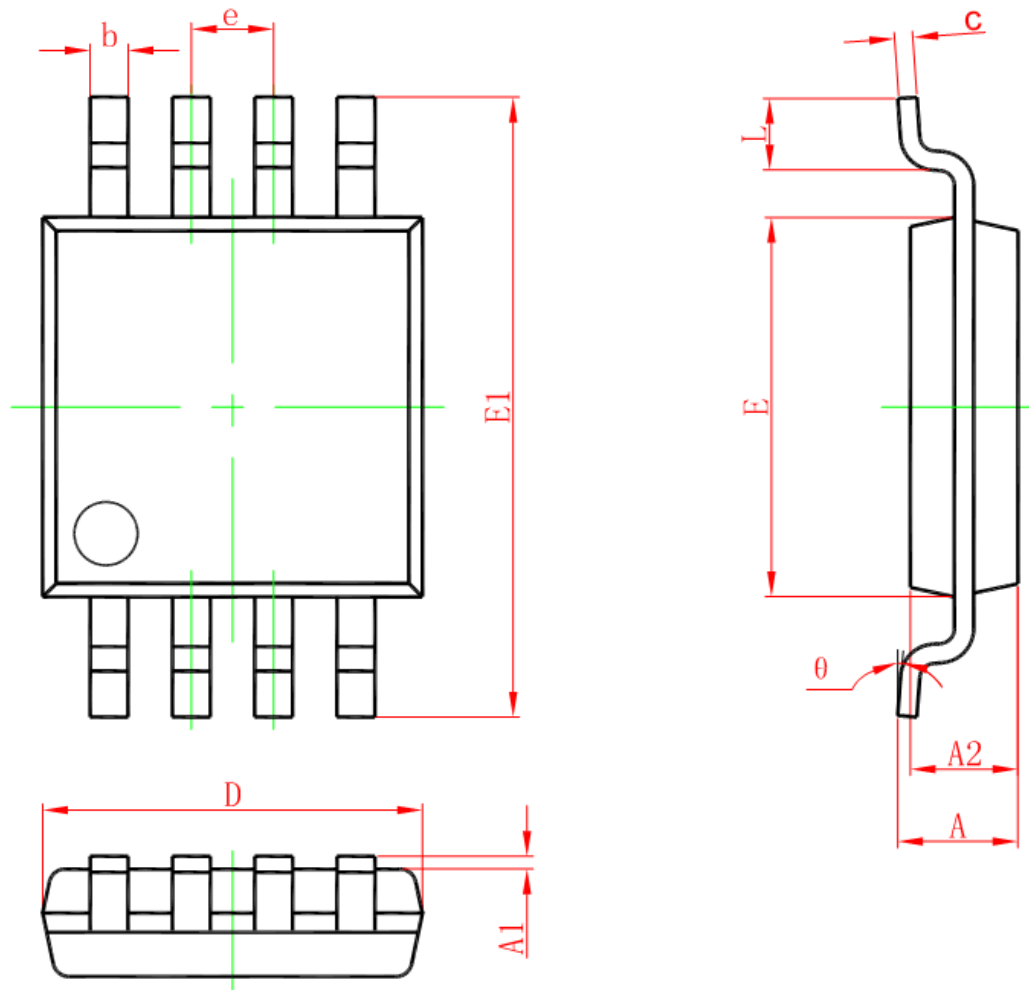

Symbol	Dimensions In Millimeters		Dimensions In Inches	
	Min	Max	Min	Max
A	0.820	1.100	0.032	0.043
A1	0.020	0.150	0.001	0.006
A2	0.750	0.950	0.030	0.037
b	0.250	0.380	0.010	0.015
c	0.090	0.230	0.004	0.009
D	2.900	3.100	0.114	0.122
e	0.650(BSC)		0.026(BSC)	
E	2.900	3.100	0.114	0.122
E1	4.750	5.050	0.187	0.199
L	0.400	0.800	0.016	0.031
$\theta$	0°	6°	0°	6°

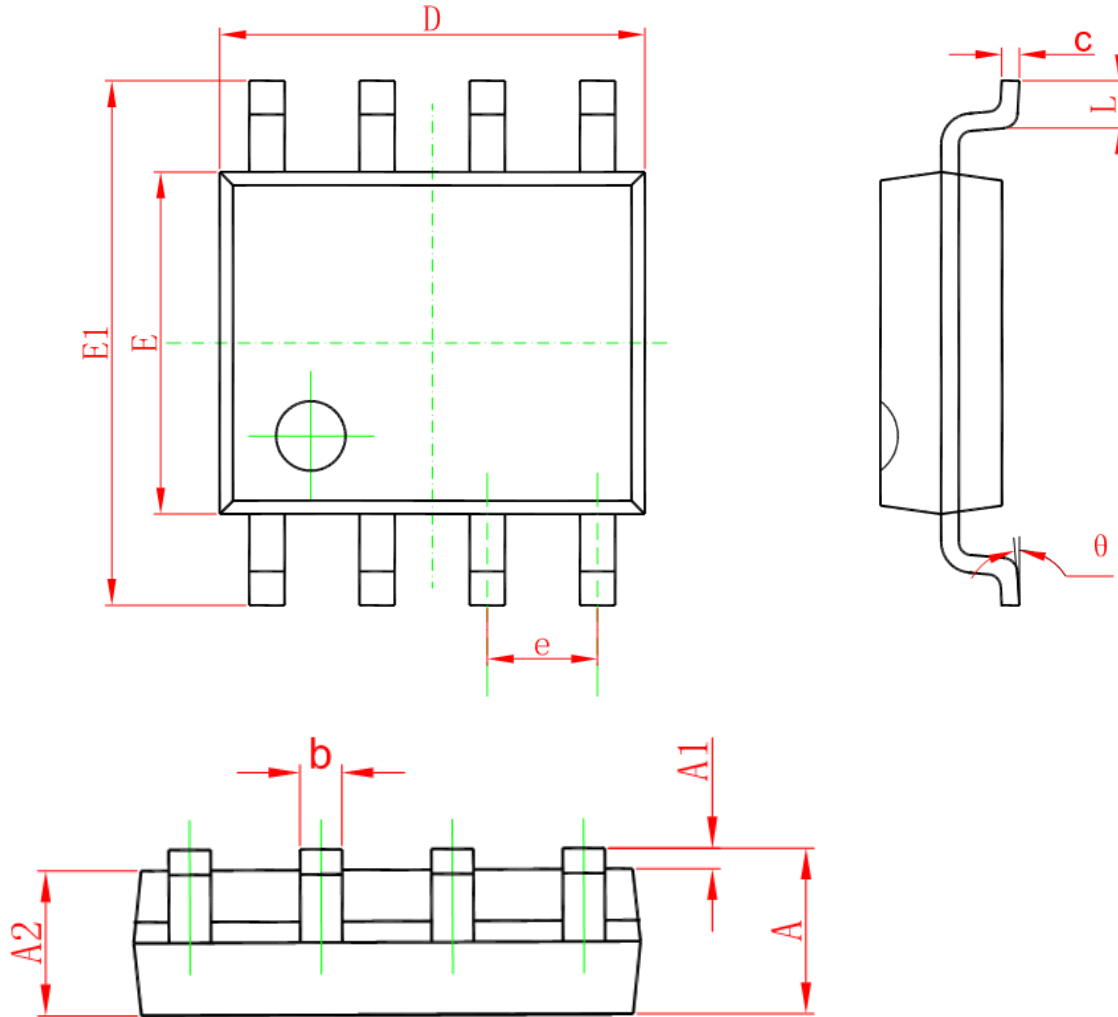

Symbol	Dimensions In Millimeters		Dimensions In Inches	
	Min	Max	Min	Max
A	1.350	1.750	0.053	0.069
A1	0.100	0.250	0.004	0.010
A2	1.350	1.550	0.053	0.061
b	0.330	0.510	0.013	0.020
c	0.170	0.250	0.006	0.010
D	4.700	5.100	0.185	0.200
E	3.800	4.000	0.150	0.157
E1	5.800	6.200	0.228	0.244
e	1.270 (BSC)		0.050 (BSC)	
L	0.400	1.270	0.016	0.050
θ	0°	8°	0°	8°